

INTERIOR DOOR RANGE 2017 | 2018

Doors for a beautiful home



INTRODUCTION

WHAT DOES YOUR PERFECT DOOR LOOK LIKE?

That's easy: it's as unique as you are!

You want doors that are as individual as a tailor-made suit – doors that complement your style and the way you live. Get inspired! In this magazine you'll find information about the latest interior design trends, different styles, different kinds of doors and various ways of combining them.

But we all know that looks aren't everything – what's on the inside also counts. So from page 50 onwards we take a detailed look at the most important technical features of our doors. You'll soon see why you'll be satisfied with Westag & Getalit interior doors, even after many years.



44

decors and lacquerings

from trendy white and varied wood reproductions to exciting plain colours

3

surfaces

from hard-wearing CPL and decor foils to elegant lacquer

84

door models

from simple to classic, from country house to Design styles

6

door frame options

from round to square or profiled; for rebated and flush-closing doors with a great emphasis on design

Find exactly what you're looking for

Wondering how you'll find the door that's right for you?

Our specialist dealers are here to help, providing expert advice and planning and ensuring that installation goes smoothly.



30

kinds of glass

from transparent glass and structured glass to individual sandblasted glazing

2

door edge options

low-maintenance round edge or puristic square edge (flush-closing doors always have a square edge)

3

door leaf cores

from light honeycomb core and robust hollow chipboard core, to extremely heavy-duty solid chipboard core

Contents

Doors provide connection – and separation. They add to our wellbeing and have a considerable impact on the style of our home. At Westag & Getalit, we offer a wide range of doors. Take advantage of our thousands of possible combinations and create a door whose design, function and quality are a perfect match for you and your lifestyle.



Current trend:
oak – a modern classic **14**



Effective ways to minimise
the risk of burglary **62**



46 Great all-rounders:
doors with PortaLit® CPL surfaces

TRENDS AND TIPS

- 2 What does your perfect door look like?
- 6 Top trend: white
- 14 Oak – a modern classic
- 18 Country house meets contemporary
- 26 Doors with coloured lacquer

DoorMODELS AND RANGES

- 10 Doors with glass openings
- 12 Doors with muntins
- 16 Design doors: View
- 18 Country house doors: Provence
- 28 Design doors: Westaline
- 32 Design doors: Smartline
- 34 Design doors: Lineo
- 36 Sliding door systems

Illustration on front page: door with strip aperture, View Type 2204 in PortaLit® pine light cross (PIC 11), Satinato glazing (see also p. 16 onwards)



18 Variety is the spice of life:
Provence country house doors



Our tip: see our entire interior door range with just a few clicks at links.westag-getalit.de/doorrange



28 For lovers of design and attention to detail: Westaline door series



40 We care about the environment

SURFACES, DECORS, GLASS OPTIONS

- 40 Westag quality – good for the environment
- 42 Glazing collection
- 44 PortaLit® – finishes you can see and feel
- 46 PortaLit® – CPL door sets
- 48 DekoRit® – Decor door sets
- 49 WestaLack® – Doors with lacquer finishes
- 50 Overview of all finishes

TECHNICAL DETAILS – FEATURES THAT COUNT

- 52 Door structures
- 54 Door frames
- 56 Door sizes
- 57 Technical terms
- 58 Hinges and locks
- 59 Apartment entrance doors

The figures may contain colour deviations due to the printing process. Subject to technical modifications.

WHITE ISN'T REALLY A COLOUR? – TRUE, BUT IT'S A PERFECT CHOICE FOR DOORS

Some doors blend discreetly into the background, while other doors hog the limelight. White doors can do both. Thanks to their neutral, gentle appearance, they lend bright rooms an extra-vibrant touch while ensuring that the furnishings remain the centre of attention. And white doors can become an eye-catcher in their own right when combined with walls and floors in strong, deep colours. Given how versatile they are, it's no wonder that the majority of doors sold are white.



PortaLit® door in
coco bolo white (CB 225)



Find more details about white finishes on the following double page and from page 47 onwards



WHITE – AS VARIED AS YOUR DESIGN PREFERENCES



Surfaces

alpine white (NCS S0505-R60B)

PortaLit® CPL

arctic white (RAL 9016)

PortaLit® CPL ¹⁾

WestaLack® lacquered

classic white (RAL 9010)

PortaLit® CPL ¹⁾

DekoRit® decor foil ^{1) 2)}

WestaLack® lacquered

plain white (RAL 9010)

PortaLit® CPL

DekoRit® decor foil ²⁾

**ash tree
white pore**

PortaLit® CPL

DekoRit®
decor foil ²⁾

White can be so much more than just white

Home is where we feel most comfortable. It's where the family comes together, where we meet our friends, and where we live, love and laugh. Within our own four walls we can simply be ourselves. And interior doors can really make a house feel like a home. They're the fittings that we look at and

touch most frequently, which is why it's so important that our doors match our style and our taste. This applies to white doors in particular. Because white is so much more than just white. At Westag & Getalit you can choose from a wealth of features to create the perfect white door for you. We offer a wide

range of different types of doors, decors and surfaces, from cold to warm, plain-coloured to wood, PVC foil to lacquer.

The choice is yours!

¹⁾without Provence country house doors ²⁾without Lineo Design doors

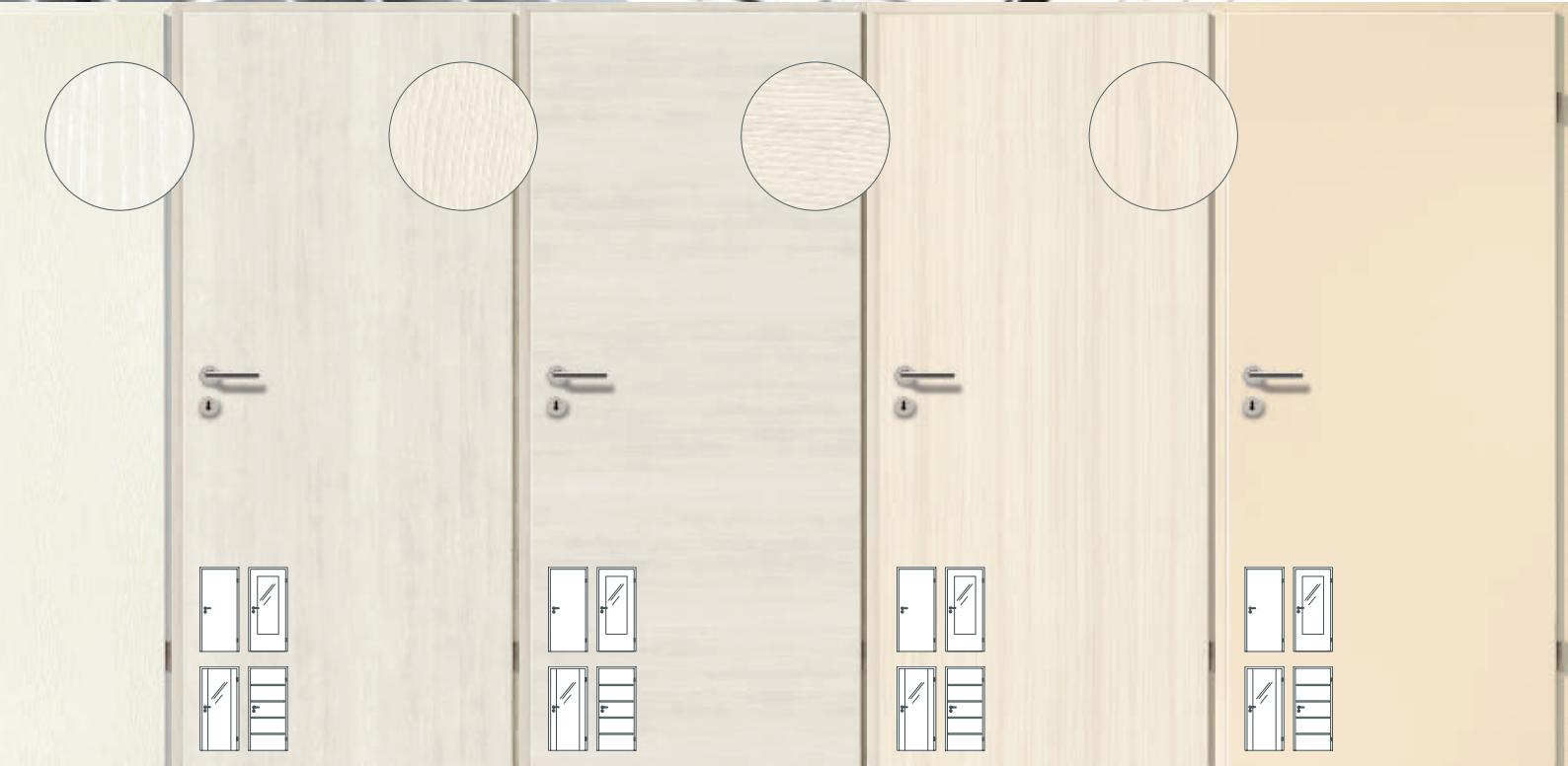
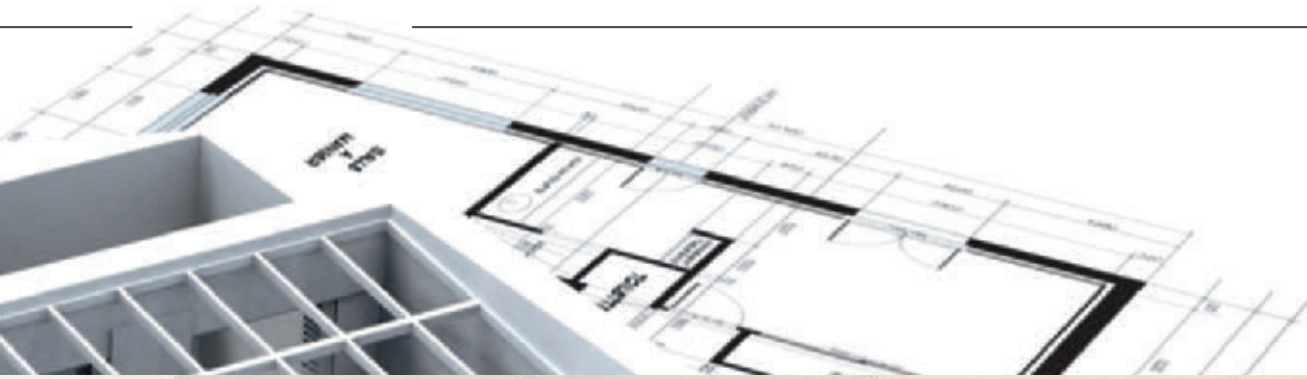

pine white
PortaLit® CPL

pine white cross
PortaLit® CPL

coco bolo white
PortaLit® CPL

sand
PortaLit® CPL

What shade of white is right for me?

This short checklist can help you decide:

- What are the dominant colours in my home?
- What colours are the walls, floors, windows, light switches and furniture?
- Are cold or warm white tones more likely to match?
- Might cosy, white woods be suitable?
- Do I prefer a certain kind of door surface?

Which door series is my favourite?



Standard doors



Doors with glass openings



Doors with muntins



Design View



Country house Provence

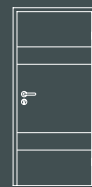

Design Westaline



Design Lineo

LET THE LIGHT IN



Glass opening door LA-DIN
in Portalit® classic white (A 223), glazing: transparent glass

Simply stunning – transparent doors at affordable prices

Direct light where it's needed and create transparency between rooms: doors with see-through panels are available to suit every budget and in many varieties – with round or angular glass openings and to fit both modern and classic styles. The glass is contained by glass beads in matching colours.



| Type LA-KR¹⁾ |
350
Transparent glass



| Type LA-DIN |
Transparent glass



Find all of the door and glass options in this series online:
links.westag-getalit.de/glassopenings

¹⁾ Glass beads available in stainless-steel effect

DOORS WITH GLASS OPENINGS



Glass beads in a matching colour hold the glass securely in place.



| Type LA-1000 |
Transparent glass



| Type LA-100 |
Transparent glass



| Type LA-40 |
Transparent glass



| Type LA-3 |
Transparent glass



| Type LA-3Q |
Transparent glass



| Type LA-1 |
Transparent glass



| Type LA-1D |
Transparent glass



| Type LA-1B |
Transparent glass



| Type LA-18-21.5 |
Transparent glass



Doors illustrated are in Portalit® decor classic white (A 223).

Doors with glass openings are available for Westag's entire range of surfaces. All decors and finishes can be found on pages 47-49. Suitable safety-glass options can be found on pages 42-43.

Further information about the glass beads can be found on pages 50-51.

ELEGANT TRANSPARENCY



Doors illustrated are in PortaLit® decor plain white (A 242). All available muntin frame decors can be found on pages 50–51. Suitable safety-glass options can be found on pages 42–43.



| LA-DIN |
Muntin 5
Transparent glass



| LA-DIN |
Muntin 1
Transparent glass



| LA-DIN |
Muntin 2
Transparent glass



| LA-DIN |
Muntin 3
Transparent glass



| LA-DIN |
Muntin 4
Transparent glass



Find all of the door and glass options in this series online:
links.westag-getalit.de/muntins



Glass opening door LA-1 with muntin 1.3 in PortaLit® plain white (A 242), glazing: transparent glass with sandblasted glass at the centre



Made-to-measure: perfectly fitted muntins and a combination of transparent and satin-finished glass give these doors a premium look.



| LA-1 |
Muntin 1.1
Design glazing



| LA-1 |
Muntin 1.2
Design glazing



| LA-1 |
Muntin 1.3
Design glazing

Adding a touch of light – with openings large and small

Light has a great impact on our wellbeing. Doors with glass openings and muntin frames make the most of the lighting conditions in a room, creating a warm, cosy atmosphere. These eye-catching doors are available with large and small glass openings and come in a range of different decors. The muntin frames add interest to the glass openings and provide some structure. The combination of transparent glass and satin-finished glass in the narrower version lends it a designer touch.

OAK – FROM 1970S WALL UNITS... TO THE LATEST DESIGNS!

Think oak is out of date? Think again! This high-density, vibrant wood from the domestic oak tree has once again become something of a favourite in premium furniture manufacturing – and rightly so. Modern oak is much lighter – a world away from the rustic appearance it used to have.

Doors with oak decor make a real statement in modern homes. The new, gentle colours complement both the new country style and more puristic surroundings.



View Design door, Type 2211 in PortaLit® platinum oak cross (EiC 424), glazing: Satinato



For further oak decors see page 47 onwards.

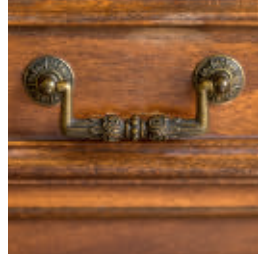

Wood reproductions based on real veneers have a harmonious, elegant effect. These extremely robust surfaces have particularly attractive structures and are durable enough to withstand all kinds of day-to-day demands.

platinum oak cross
(EiC 424)

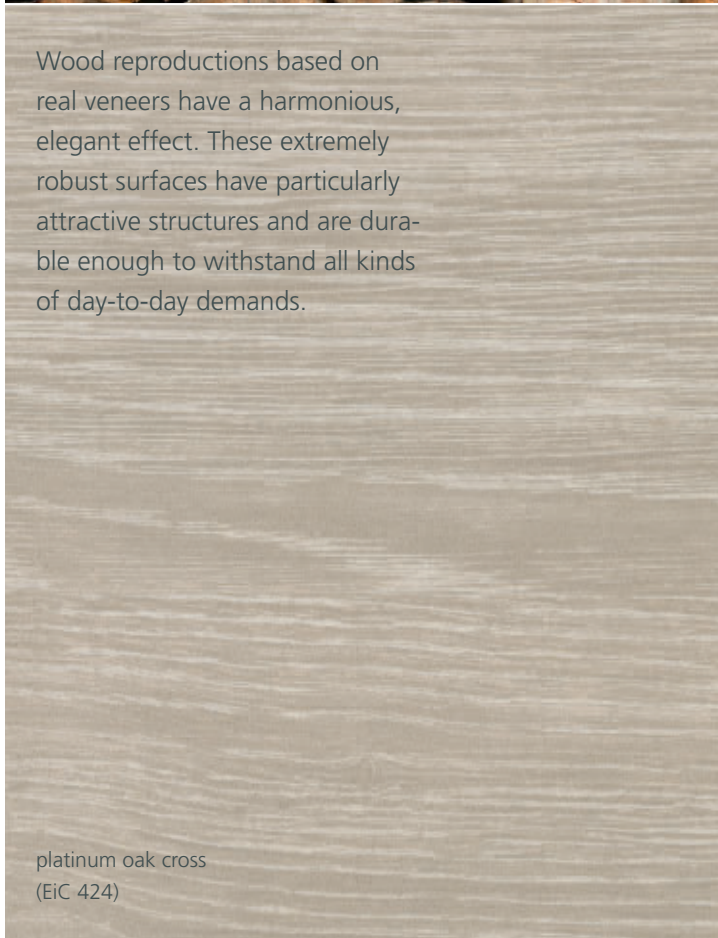

platinum oak
(Ei 424)

Oak decors with transverse grain patterns are particularly distinctive.

amber oak cross
(EiC 727)



amber oak
(Ei 727)

WHERE LIGHT LEADS THE WAY



The puristic integration of glass elements without glass beads elevates these doors to striking designer pieces in their own right.



View door Type 2211, flush closing with hidden hinges Tectus TE 340 3D in Portalit® amber oak cross (EiC 727) with Satinato glazing

Design doors with strip apertures – for every room

Homes and rooms are becoming more and more open and transparent. And this applies to our doors, too. Design doors with strip apertures allow for refreshing interior and exterior views and make rooms brighter and more pleasant. From large glass surfaces to narrow strip apertures, you can choose what's right for your home. And it doesn't have to be transparent glass: sandblasted and satin-finished glass are also a fantastic match for our smooth Design surfaces.



| Type 2100 |
Motif 3 x 9



| Type 2100 |
Motif 2 Lines
negative



Find all of the door and glass options in this series online:
links.westag-getalit.de/view-en

VIEW | DOORS WITH STRIP APERTURES



| Type 2201 |
Motif Diskret
negative



| Type 2202 |
Motif Lines



| Type 2203 |
Motif Curves
negative



| Type 2209 |
Motif Straight



| Type 2204 |
Motif Spider



| Type 2211 |
Satinato



Doors illustrated are in PortaLit® decor amber oak cross (EiC 727).

The 'View' range of doors is available in Westag's entire range of surfaces. All decors and finishes can be found from page 47 onwards. Corresponding safety glass options can be found on pages 42–43.

COUNTRY HOUSE AND CONTEMPORARY STYLES DON'T GO TOGETHER? OF COURSE THEY DO!



When it comes to the typical country house style, you don't have to just stick to romantic, playful elements anymore. The latest country house trend is fresh, low-key and uninhibited. And it allows you to combine different styles to your heart's content: think design classics placed next to rustic furniture, or vintage industrial objects displayed alongside traditional, handcrafted items. It's an exciting mix, and doors can play very different roles here – adding a pop of colour or providing a warm, tone-on-tone effect. Available in all the lacquers pictured above.



Provence door Type 4002 in WestaLack® classic white (RAL 9010)



The following pages feature over 20 models



MIX AND MATCH



Stylish profiles in the surface lend the door its typical country house character.



| Type 4004 |



| Type 4004-LA |
Motif Classico
negative



| Type 4004-
2LA |
Transparent glass



| Type 4004-2LA |
Muntin 12
Transparent glass



| Type 4004-LA |
Muntin 6
Transparent glass



| Type 4004-LA |
Muntin 7
Transparent glass

Country house style – a bold combination

At home in the city too, our Provence country house doors are versatile and go with all different kinds of interiors, whether they're classic and simple or minimalist and modern. When combined with cool, pared-down home interiors, they create striking contrasts. Why not give it a try yourself: simply upload a photo of your desired room to our door configurator, and off you go!



Find all of the door and glass options in this series online:
links.westag-getalit.de/provence-en



Provence door Type 4004 in WestaLack® classic white (RAL 9010)



| Type 4002-LA |
Transparent glass



| Type 4002-LA |
Motif Palmette



| Type 4002-LA |
Motif Rosette



| Type 4002-LA |
Motif Spider
negative



| Type 4002-LA |
Muntin 3
Transparent glass



| Type 4002-LA |
Muntin 4
Transparent glass



| Type 4002-LA |
Muntin 10
Mot. Romantica
neg.



| Type 4002-LA |
Muntin 11
Motif Imperial



| Type 4002 |



Doors illustrated are in WestaLack® classic white (RAL 9010). The 'Provence' door series is available in the entire WestaLack® collection; see page 49. Safety glass options can be found on pages 42-43.



COUNTRY HOUSE STYLE WITH A TOUCH OF ELEGANCE



Doors created with loving attention to detail: the beads surrounding the glass match the door profile. Fine grooves between the cassettes add to the country house look.



Doors illustrated are in WestaLack® classic white (RAL 9010).
The 'Provence' series is available in the entire WestaLack® collection; see page 49.
Suitable safety-glass options can be found on pages 42-43.



| Type 4004-Q |



| Type 4004-Q-LA |
Transparent glass



| Type 4004-Q-2LA |
Transparent glass



| Type 4004-Q-3LA |
Transparent glass



| Type 4004-Q-LA |
Muntin 14
Transparent glass



| Type 4004-Q-2LA |
Muntin 13
Transparent glass



Find all of the door and glass options in this series online:
links.westag-getalit.de/provence-en



Provence door Type 4004-Q and Type 4004-Q-2LA in WestaLack® classic white (RAL 9010), glazing: transparent glass



The frame application Type Classic goes well with | Type 4004 |



The country house frame application type goes well with | Type 4004-Q |

Eye-catching doors that make a house a home

Trend-watchers are talking about a new kind of comfort, and this is reflected in our Provence country house doors. They are a great match for spaces with warm tones, solid furniture and soft materials. Thanks to their semi-matt lacquering, the doors look elegant and feel pleasant to the touch. Frame applications add to their tasteful appearance. These statement doors are ideal in rooms with high ceilings and large windows.



Frame applications are available for one or both sides of the door.

A TOUCH OF ROMANCE



Provence door Type 4002-B-LA with muntin 8 in WestaLack® classic white (RAL 9010), Romantica sandblasted glass, profiled door frame P1

Loving attention to detail

'Home is not just a place – it's a feeling.' The romantic Provence Roman arched doors create the kind of atmosphere that makes you want to take it easy and let body, mind and soul relax. Curved lines meet striking muntins, and the light shines softly through the glass openings, accentuating the details and patterns in the individual sandblasted glass panels. Provence country house doors are also available with the more understated glass options from the Westag & Getalit glass collection.



| Type 4002-B |



| Type 4002-B-LA |
Motif Rosette



Find all of the door and glass options in this series online:
links.westag-getalit.de/provence-en



Curved beading and premium sandblasted glass are reminiscent of traditional craftsmanship.



| Type 4002-B |
Muntin 5
Transparent glass



| Type 4002-B-LA |
Transparent glass



| Type 4002-B-LA |
Motif Palmette



| Type 4002-B-LA |
Motif Imperial



| Type 4002-B-LA |
Muntin 8
Motif Florale



| Type 4002-B-LA |
Muntin 9
Mot. Romantica
negative



Doors illustrated are in WestaLack® classic white (RAL 9010). The 'Provence' series is available in the entire WestaLack® collection; see page 49. Suitable safety-glass options can be found on pages 42–43.



Our recommendation
P1 profiled door frames are a particularly good match for the 'Provence' door series.

LACQUERED DOORS – NOT JUST FOR RETRO INTERIORS!



The growing trend towards customised interior design shows no sign of slowing down. Increasingly, we're seeing various styles – including retro, open loft style, cocooning, opulent, puristic and natural – being combined in a single space. That's why our lacquered doors are now available in a range of unique colours. You can choose from the six options pictured above, for doors that match your own personal style. Have fun!



For more information about the WestaLack® colour collection, go to page 49



Westaline doors 2505-LB-Q with strip aperture in Satinato glazing and Type 2505 in WestaLack® trend lacquer agate (RAL 7015)

PERFECT FOR PURISTS



Westaline door Type 2505-LB and Type 2505, flush closing with hidden hinges
Tectus TE 340 3D in WestaLack® classic white (RAL 9010), with Fourliner sandblasted glazing

Design between the lines

Our Westaline doors are made for those who love good design: puristic, pared down and bold. The stylish groove detailing lends structure to the door and highlights its elegant simplicity and straight lines. The horizontal grooves form an interesting contrast to the door's height. And for added light, there are embedded strip apertures or, in the more cost-effective version, fitted glass openings.

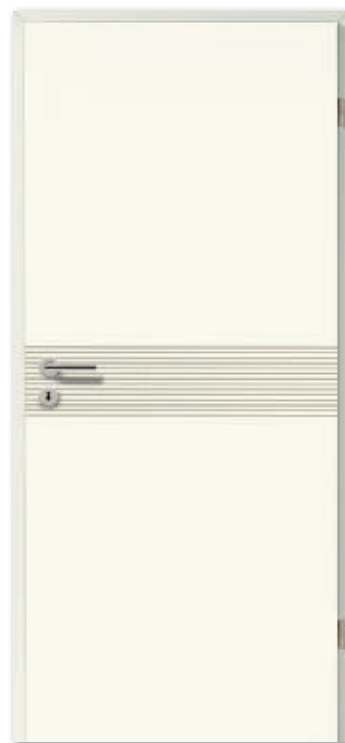

| Type 2514 |



| Type 2510 |



| Type 2513 |



| Type 2504 |



| Type 2504-LB |
Motif Spider



Find all of the door and glass options in this series online:
links.westag-getalit.de/westaline-en



The horizontal V-shaped joints cast a delicate shadow, giving this simple, elegant design a very special appeal.



| Type 2505 |



| Type 2505-LB |
Motif Fourliner



| Type 2505-LB-Q |
Motif Straight
negative



| Type 2505-
LA-DIN |
Transparent glass



| Type 2505-LA-1 |
Transparent glass



| Type 2505-LA-1D |
Transparent glass



| Type 2505-LA-1B |
Transparent glass



Doors illustrated are in Westalack® classic white (RAL 9010).
The 'Westaline' series is available in the entire Westalack® collection; see page 49.
Suitable safety-glass options can be found on pages 42–43.

FURTHER PERSPECTIVES FOR PURISTS

No matter whether they are horizontal or vertical, the carefully cut V-joints turn flush-closing doors, in particular, into designer items.

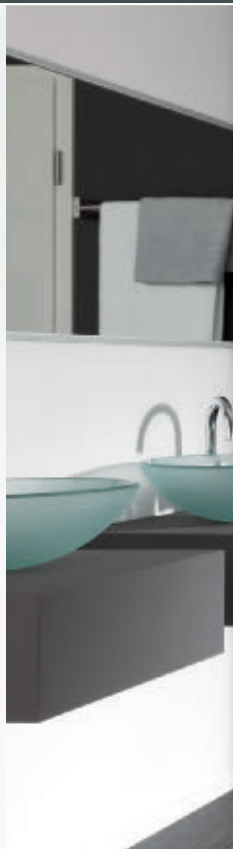

| Type 2501 |



| Type 2501-LB |
Transparent glass



| Type 2502 |



| Type 2503 |



| Type 2502-LB |
Transparent glass



| Type 2503-LB |
Transparent glass



Find all of the door and glass options in this series online:
links.westag-getalit.de/westaline-en



Westaline door Type 2508 in WestaLack® classic white (RAL 9010)

Design on all planes

Those who are passionate about interior design love Westaline. The V-shaped grooves play with the light, conjuring up delicate shadows on the semi-matt surfaces. Vertical joints emphasise the door's slender appearance, while built-in strip apertures allow for interesting views. Combining horizontal and vertical grooving is also an option. And, of course, Westaline doors don't have to be white. The lacquered designer doors are available in six inspiring colours (see page 26).

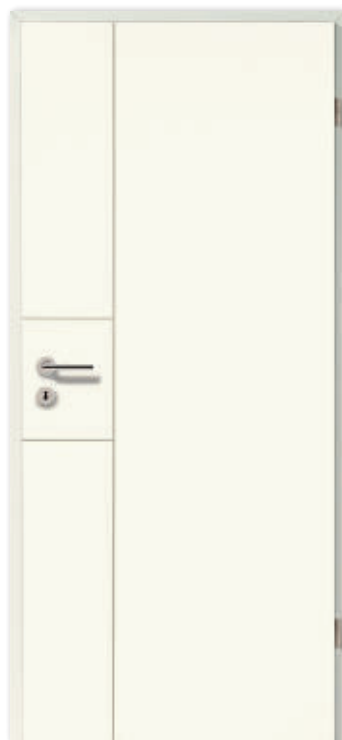

| Type 2508 |



Doors illustrated are in WestaLack® classic white (RAL 9010). The 'Westaline' series is available in the entire WestaLack® collection; see page 49. Suitable safety-glass options can be found on pages 42–43.



THE SMART WAY TO ENJOY GREAT DESIGN



Smartline door Type 5505 in DekoRit® classic white (DE 223)

Good design doesn't have to cost a lot

Smartline is for those who love good design and are smart with their money. The decor foil surface looks like white lacquer. Softly rounded grooves accentuate the door's horizontal lines, and the joints are embossed and slightly broader – all of which creates a timeless modern effect. The four Smartline models are available in the version DekoRit® classic white.

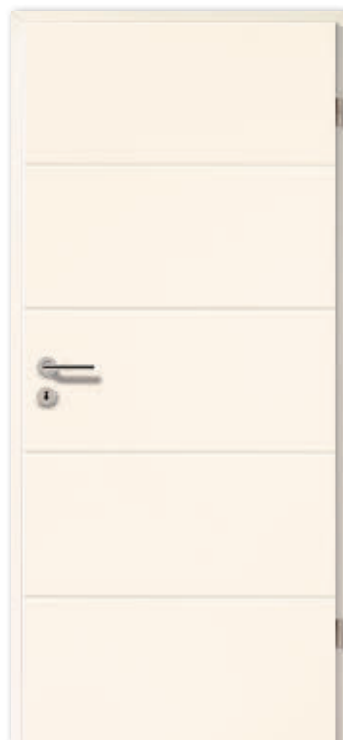

| Type 5505 |



The 'Smartline' series is available in DekoRit® decor foil classic white (DE 223).

Suitable safety-glass options can be found on pages 42–43.

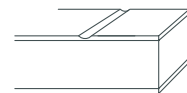

Find all of the door and glass options in this series online:
links.westag-getalit.de/smartline-en

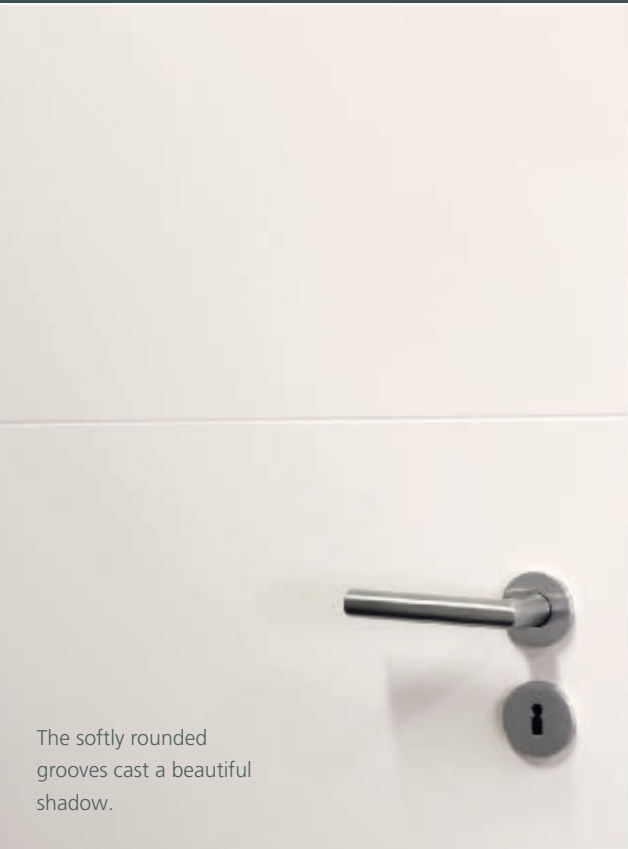

The softly rounded grooves cast a beautiful shadow.

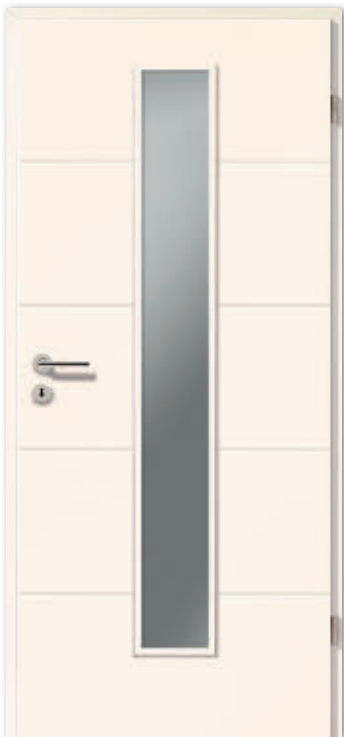

| Type 5505-LA-1 |
Transparent glass



| Type 5505-LA-1D |
Transparent glass

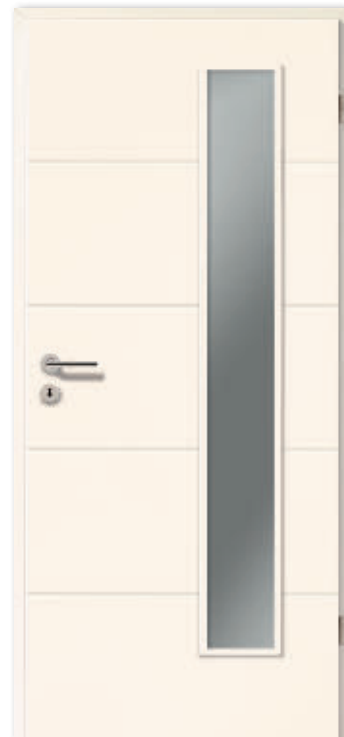

| Type 5505-LA-1B |
Transparent glass

DESIGN WITHOUT COMPROMISE



Lineo door Type 3605 in Portalit® agate (A 411)

Small details – huge impact

Lineo stands for pared-down design with maximum effect. The series combines strong colours and narrow stainless-steel-effect inserts, creating a perfect balance. The custom-fit inserts are embedded in the door leaf. The result: aesthetic flair you can both see and feel.



| Type 3605-LB |
Transparent glass



| Type 3605-LB-Q |
Transparent glass



| Type 3605 |



| Type 3605-
LA-1 |



Find all of the door and glass options in this series online:
links.westag-getalit.de/lineo-en



Embedded, slightly protruding stainless-steel-effect strip inserts give these doors their special appeal.



| Type 3606 |



| Type 3604 |



| Type 3601 |



| Type 3602 |



| Type 3603 |



| Type 3604-LB |
Transparent glass



| Type 3601-LB |
Transparent glass



| Type 3602-LB |
Transparent glass



| Type 3603-LB |
Transparent glass



Doors illustrated are in PortaLit® agate (A 411). 'Lineo' series available in the surface collections PortaLit® and WestaLack®; see pages 47 and 49. Suitable safety-glass options can be found on pages 42–43.

ELEGANT SPACE SAVERS



Practical and eye-catching

Sliding doors are amazing space savers. They open up our homes and make it easier to move around them. Ideal for small rooms, alcoves and narrow hallways, these doors glide gently along the wall. Slim and distinctive, they are easy to install and can be retrofitted. Our sliding doors are available with or without frames, as lockable versions and to match your other doors – choose whatever suits you.



Elegant, functional and subtle, they go with any interior style. Also available as lockable versions (warded lock, profile cylinder lock or bathroom door lock) when combined with an end post.



Sliding door running in front of the wall in PortaLit® classic white (A 223)

Construction variants

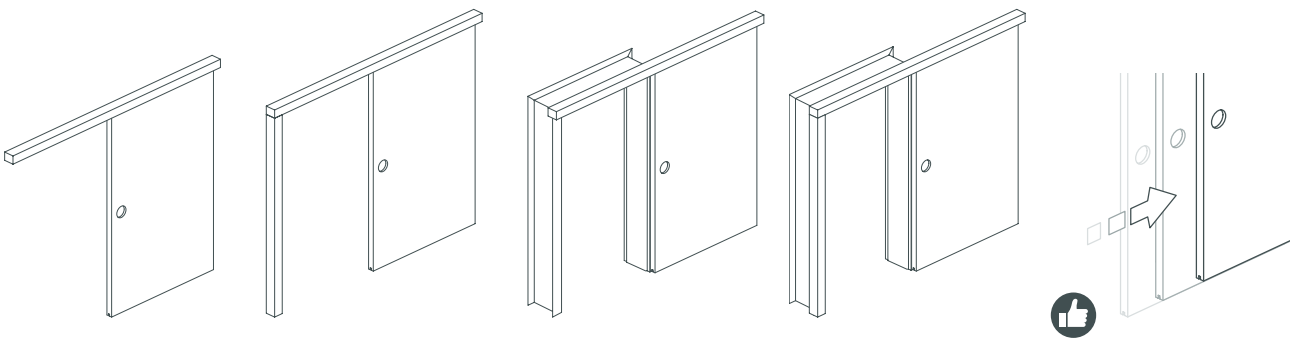

The basic version: the sliding door element is fitted directly upon the wall. A high-quality guide rail ensures that the door slides quietly and smoothly. The discreet cover angle in a matching decor covers the guide rail completely. It doesn't get any simpler than this.

The basic version (left) is extended using an end post. This construction allows the sliding door to be locked.

For anyone wishing to hide the open wall reveal, a sliding door construction including door frame is the right choice.



Our recommendation
Can also be retrofitted using existing Westag door frames.

The sliding door construction with door frame (left) is extended using an end post that allows the sliding door to be locked. No further equipment is required.



Our recommendation
All sliding door elements can be fitted with an optional damping function for opening and closing.

THE STYLISH WAY TO CONNECT ROOMS



The matt shell handle makes the door easy to operate .

Practical, beautiful and functional – making life easier for disabled people

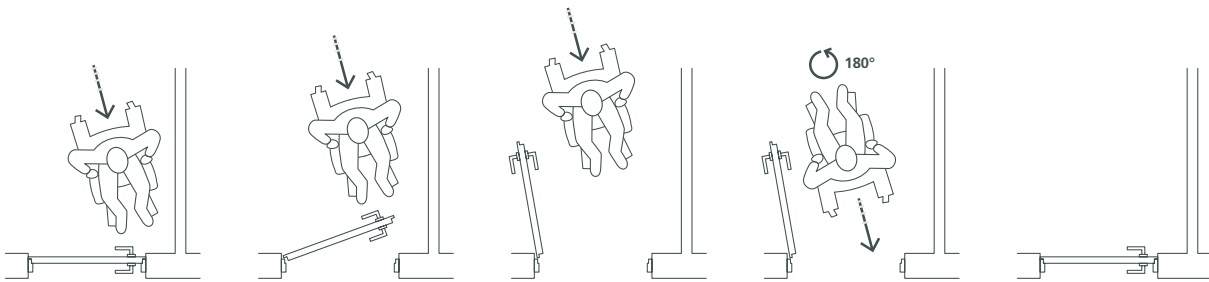

Complex manoeuvring is required when passing through a standard hinged door

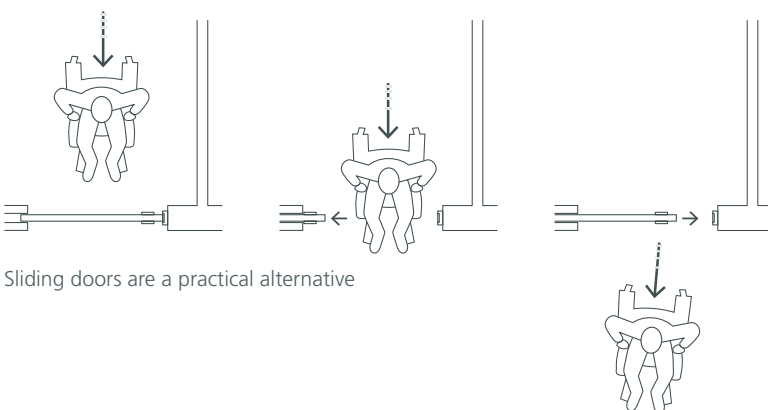

Sliding doors are a practical alternative

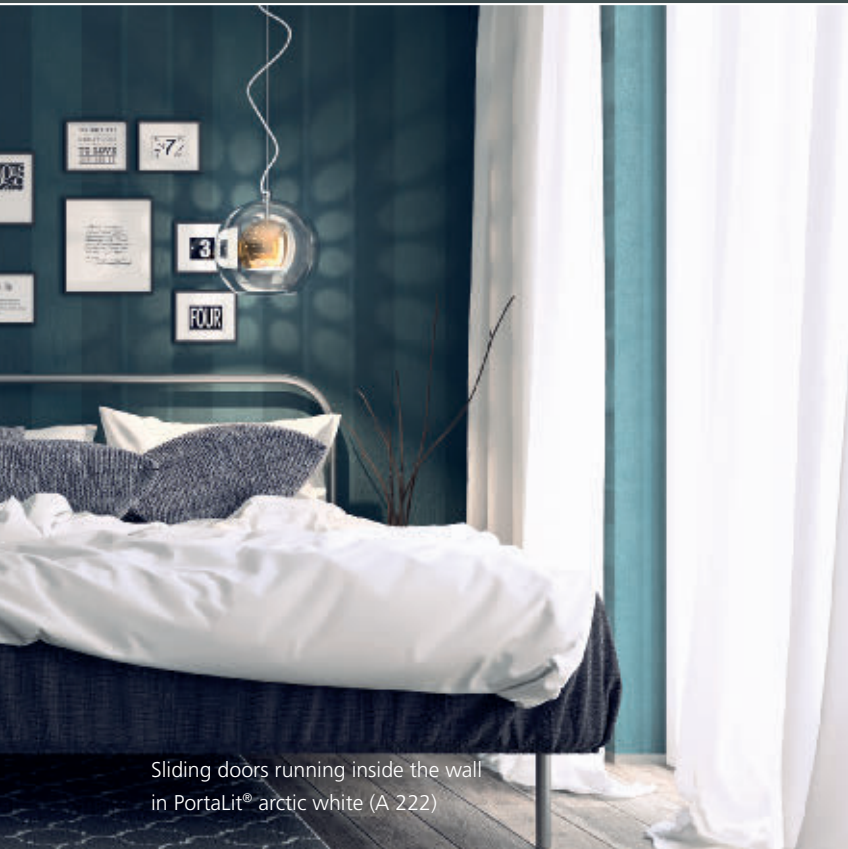

Sliding doors running inside the wall in PortalLit® arctic white (A 222)



Subtle space savers

We use certain areas of our homes for related activities: sleeping and dressing, cooking and eating, living and working. Sliding doors that run inside the wall aren't just space savers – they're also an ingenious way of connecting living areas. All it takes is a gentle hand movement and the door opens. A second hand movement, and it disappears silently into the wall. Those who are passionate about interior design love these doors, since they free up space on the wall for pictures, lamps and other accessories.

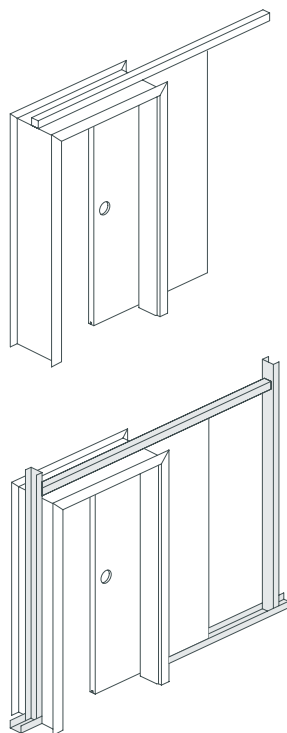

Construction variants

Sliding door system running inside the wall for customised, individual installation in the customer's existing wall openings. The transition from the wall opening to the door frame must be prepared accordingly.

Sliding door system running inside the wall for prefabricated cabinet systems. The prefabricated constructions by well-known manufacturers are installed in drywall or masonry. The specially designed door frame covers the edges of the wall opening reliably.

□ included in delivery ■ parts from other suppliers



AN AVERAGE DOOR SHOULD LAST AROUND 40 YEARS. SO IT'S WORTH PAYING ATTENTION TO A FEW IMPORTANT DETAILS.

Made in Germany

As the market leader in PVC foil-coated interior doors, we learnt our craft from scratch. Westag & Getalit has been manufacturing its products in Germany for over 100 years. This is where we have found the conditions we need to be able to produce individual doors of certified quality.

Thinking and acting responsibly

Our mission is to be of service to people and to protect the environment. The wood that your door is made from is sourced from sustainable forestry and is processed without the use of chemicals that are harmful to the environment and to human health. We have high production standards and use modern, environmentally friendly processes that we are continually improving. Our own QA laboratory, independent audits and strict controls ensure the quality of our products.

All-round service

When you need a new door, it's best not to make an ad hoc decision – instead, talk to your nearest Westag & Getalit trade partner. They are on hand to provide you with expert, friendly advice and to help you find exactly what you're looking for.



AN OPEN VIEW

Is everything clear? Well, it actually depends which glazing you choose. That's because doors with glass panels don't always have to be simple and see-through. Discover the many different ways to bring more light into your life. We offer the right kinds of glass for every type of door, with colours, degrees of transparency, motifs and designs tailored to your requirements. And if you like, we can include an additional, certified level of safety, so that nothing gets broken and you can enjoy your new purchase with peace of mind.

The flowers in the photos show how transparent the different types of glass are.

Glazing – available for all door models with glass openings and strip apertures



Transparent glass ¹⁾



grey ¹⁾

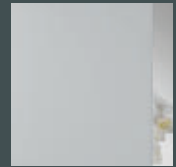

Satinato ¹⁾

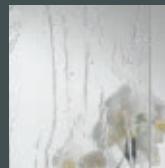

Gotik

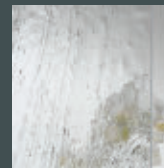

Altdeutsch K
white

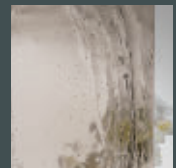

Altdeutsch K
bronze



Ornament 504



Kathedral

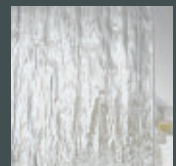

Silvit ¹⁾

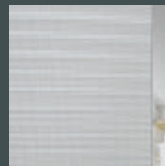

Masterpoint ¹⁾



Mastercarree ¹⁾



Masterligne ¹⁾



Chinchilla ¹⁾

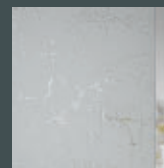

Uadi ¹⁾



Faceting
Transparent glass



Satinato white
faceting



For larger glass openings and strip apertures we recommend safety glass in compliance with DIN, which is available for many types of glass.

We use glass types from different manufacturers and therefore may use similar versions.

¹⁾ Available as safety glazing

Sandblasted glazing options for the View, Lineo, Westaline and Smartline door models and models with glass openings

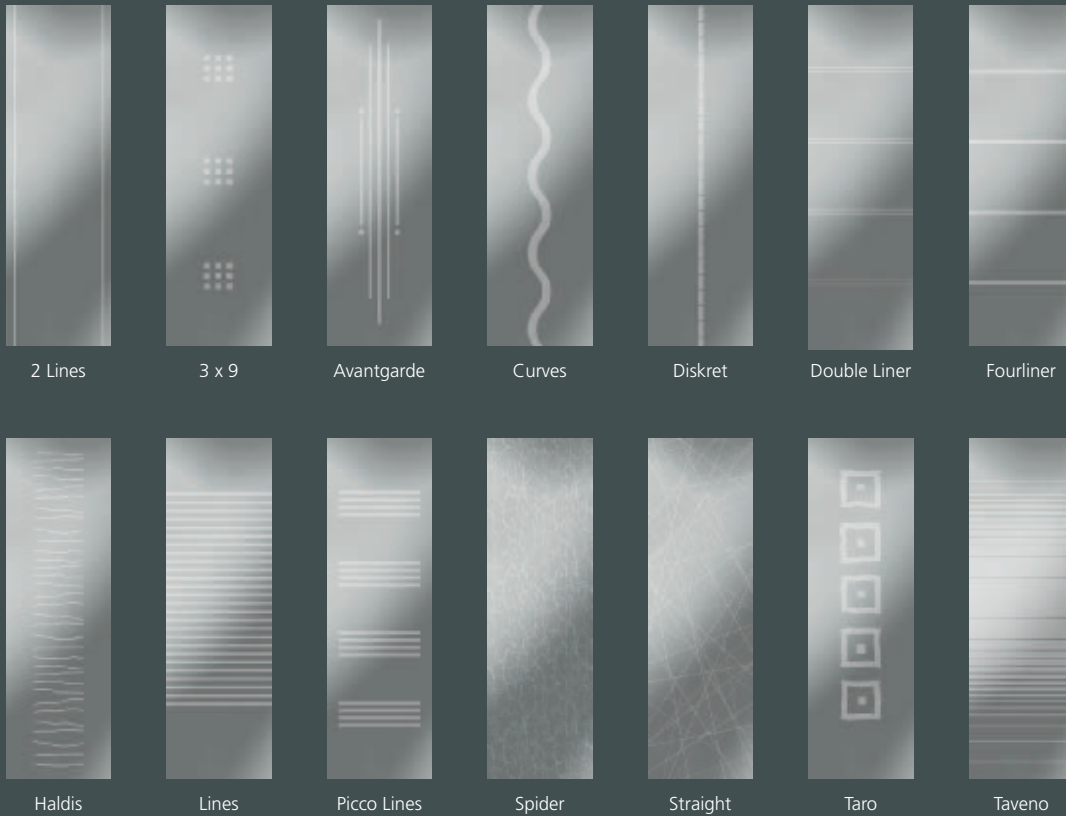

All sandblasted glazings are supplied as safety glass as standard and are also available in the colour grey.

For figures with sandblasted glass: the light side is sandblasted glazing and the dark side is transparent glass. All sandblasted glazings are also available in reversed matting if requested.

Sandblasted glazing for the View, Lineo, Westaline and Smartline door models and for the LA-1, LA-1D, and LA-1B glass openings

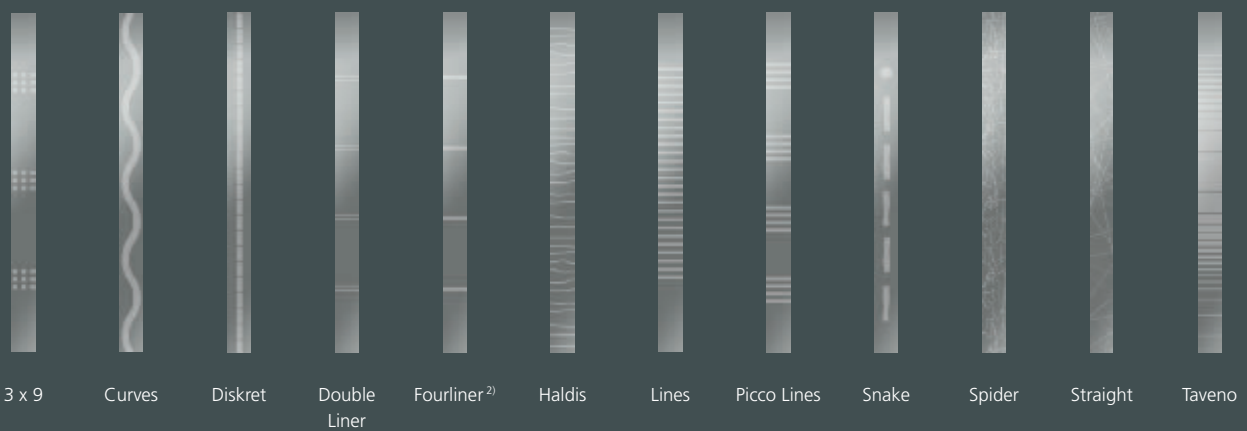

²⁾ Fits exactly to the layout of the line of the series Westaline Type 2505-LB and Lineo Type 3605-LB (see pages 29 and 34)

A PVC foil door that looks and feels like real wood? It has to be seen to be believed. Our PortaLit® CPL doors combine a real-wood effect with an extremely high level of durability. They feel pleasant to the touch and, even after many years of use, look just as good as the day you bought them. To keep them looking their best, simply wipe them down with a damp cloth.

Our PortaLit® PVC foil special-touch doors are available in the following finishes: classic touch, soft touch und pure touch.



 **classic touch**

The classic for single-colour doors. Looks like precious parchment, feels pleasant to the touch and is also hard-wearing and extremely functional.



 **classic touch**

Our tried-and-tested surface for a wood-grained look. The fine grain emphasises the wood effect and makes an especially authentic impression.

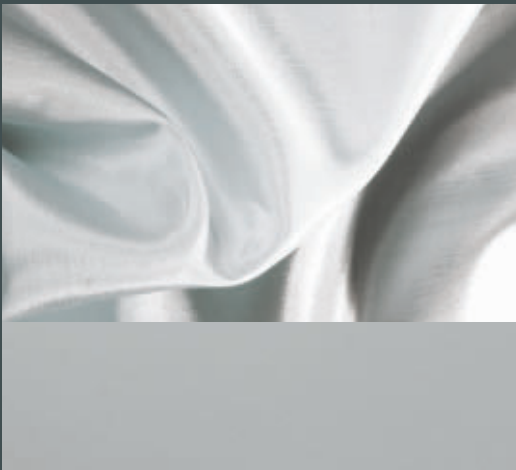

 **soft touch**

As delicate as silk but incredibly tough, this surface has a matt finish – and dust just slides off it.



 **pure touch**

With optics and surface feel in perfect harmony, this is just like the real thing. The bold wood design gives the surface a very realistic look and feel.

A DOOR THAT CAN COPE WITH ANYTHING!



EVERY DAY, MANY OF US HAVE CHILDREN RUNNING AROUND AND PLAYING IN OUR HOMES. BUT THIS ISN'T THE ONLY REASON PEOPLE NEED DOORS THAT CAN WITHSTAND ANYTHING!

Doctors' surgeries, hotels and playgroups also benefit from the practical features of our versatile products. PortaLit® CPL doors can easily withstand scratches, knocks, stains, light, steam, and even cigarette burns and household chemicals.

This is down to our special CPL procedure, during which the PVC foil surface is exposed to particularly high pressure. This results in a DIN-approved, typical, non-porous and particularly durable CPL surface. There is a PortaLit® CPL door to suit every lifestyle – from brilliant single-colour decors to natural-looking wood reproductions.

Surface properties acc. to DIN, EN, RAL¹⁾



scratch-resistant

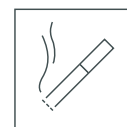

cigarette-proof

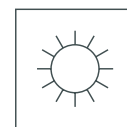

light-fast



abrasion-resistant

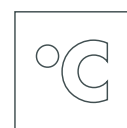

temperature-resistant



stain-proof

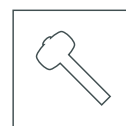

shock-proof



steam-resistant



resistant to standard household chemicals

Structure of the PortaLit® finish

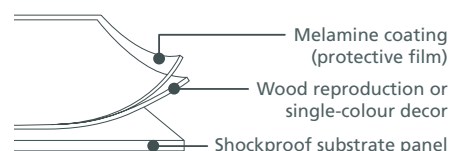

¹⁾ DIN 68765, DIN 68861, DIN 68861 7 A, DIN EN 85, EN 14322/23, RAL RG 426

**DECOR
COLLECTION
BASIC**

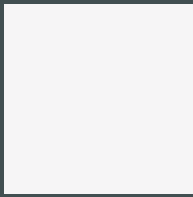

alpine white
A 221
(NCS S 0505-R60B)

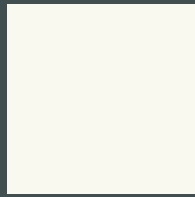

arctic white
A 222
(RAL 9016)

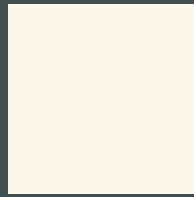

classic white
A 223
(RAL 9010)

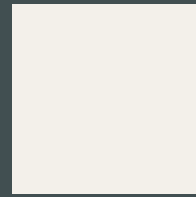

plain white
A 242
(RAL 9010)



light grey
A 402
(RAL 7035)

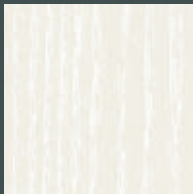

ash tree white pore
ES 242

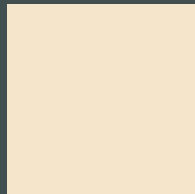

sand
A 320
(RAL 1015)



natural maple
AHB 99



rustic maple
AH 74

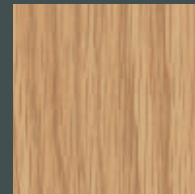

pale oak
EiB 310



flowery beech
BU 88

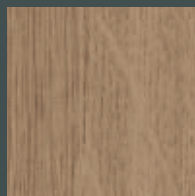

oak italia
EiP 356



walnut noce
NU 736

RAL/NCS specifications are approximations of the colour systems and may deviate depending on the surface finish.

**DECOR
COLLECTION
TREND**

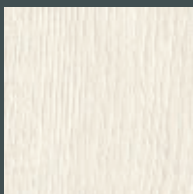

pine white
Pi 230

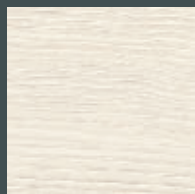

pine white cross
PiC 230



coco bolo white
CB 225



ferrum
A 460
(RAL 7047)



cement
A 446
(RAL 7004)



platinum oak
Ei 424

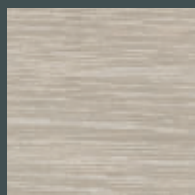

platinum oak cross
EiC 424

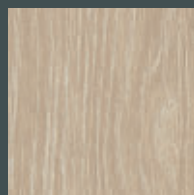

amber oak
Ei 727

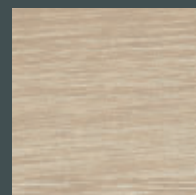

amber oak cross
EiC 727



macchiato
A 337
(RAL Design 060 60 05)

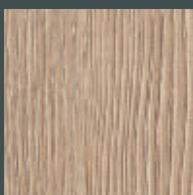

pine light
Pi 11



pine light cross
PiC 11



pine grey cross
PiC 44

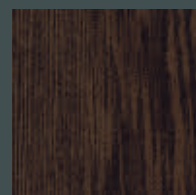

wenge
WE 716

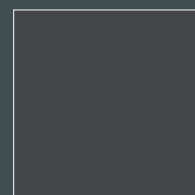

agate
A 411
(RAL 7015)

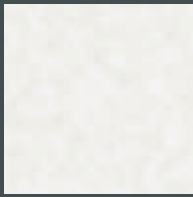

Priming film
brush-on

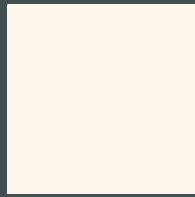

classic white
DE 223
(RAL 9010)

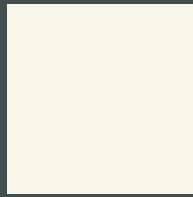

plain white
DE 24
(RAL 9010)



ash tree white pore
DES 25

**DECOR
COLLECTION
BASIC**



pine light cross
DEC 11

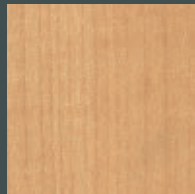

rustic maple
DE 74

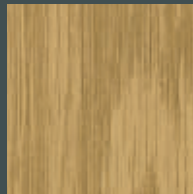

pale oak
DE 30

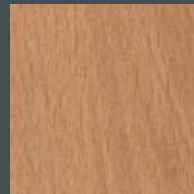

flowery beech
DE 88



walnut noce
DE 736

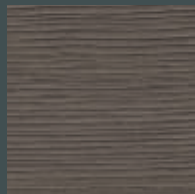

pine grey cross
DEC 44

RAL/NCS specifications are approximations of the colour systems and may deviate depending on the surface finish.



The cost-effective choice – not just for young trendsetters

Love quality and good design, but on a tight budget? Then our doors with decor foil surfaces are just what you need. DekoRit® decor foil doors are an entry-level product ideally suited to any living situation. They are easy to clean and available in a range of trendy decors. Our DekoRit® surfaces with a wood-like effect are impressive thanks to their true-to-nature reproduction.

DekoRit® surface properties



abrasion-resistant

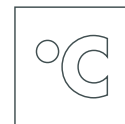

temperature-resistant

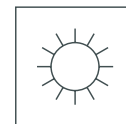

light-fast



stain-proof



resistant to gentle cleaning agents

Structure of the DekoRit® finish

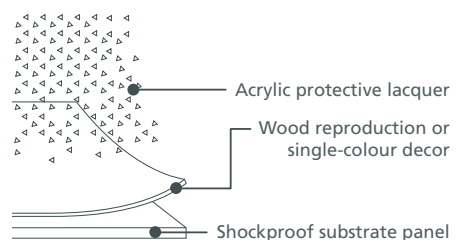

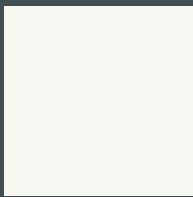

arctic white
(RAL 9016)

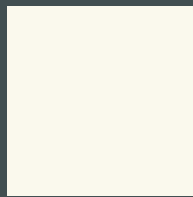

classic white
(RAL 9010)

LACQUER COLLECTION
BASIC



ferrum
(RAL 7047)

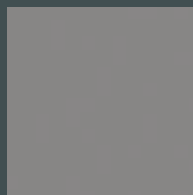

cement
(RAL 7004)



macchiato
(RAL Design 060 60 05)

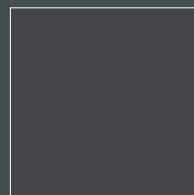

agate
(RAL 7015)

LACQUER COLLECTION
TREND



You can find surfaces with matching colours in the PortaLit® decor collection on page 47 – an ideal solution if you need more durable doors in the same colours in certain areas.



For orders of one piece or more, colours according to the RAL, NCS or ACC (Sikkens) charts are available as individual lacquer. Ask your specialist dealer for more details.

RAL/NCS specifications are approximations of the colour systems and may deviate depending on the surface finish.



Elegance for those who like to be different

Individualists with a penchant for elegant, semi-matt, lustrous surfaces choose our interior doors with lacquer finishes. Available in two basic colours, four trend colours, and, if requested, in any of the colours listed on the RAL, NCS or ACC colour charts. To protect both people and the environment, we only use environmentally friendly, water-based lacquers and solvent-free UV acrylic lacquers.

WestaLack® surface properties



abrasion-resistant



temperature-resistant

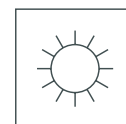

light-fast



stain-proof



resistant to gentle cleaning agents

Structure of the WestaLack® finish

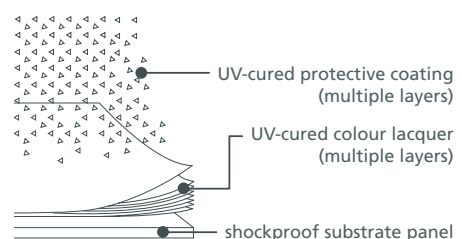

WHICH DOOR SHOULD IT BE?

Decor / lacquering		Surface structure ¹⁾	basic/ trend	RAL ²⁾ Classic	RAL ²⁾ Design	NCS ²⁾
Abbreviated name	Decor name					
PortaLit DOORS WITH CPL FINISH						
A 221	alpine white	soft touch	basic			S 0505-R60B
A 222	arctic white	soft touch	basic	RAL 9016		S 0502-G
A 223	classic white	soft touch	basic	RAL 9010	100 90 05	S 0500-N
A 242	plain white	classic touch	basic	RAL 9010		S 0502-G
A 320	sand	soft touch	basic	RAL 1015	080 90 10	S 1005-Y30R
A 337	macchiato	soft touch	trend	RAL 7048	060 60 05	
A 402	light grey	classic touch	basic	RAL 7035		S 2002-G
A 411	agate	soft touch	trend	RAL 7015	260 40 05	S 6502-B
A 446	cement	soft touch	trend	RAL 7004	000 65 00	S 4500-N
A 460	ferrum	soft touch	trend	RAL 7047	000 80 00	S 2000-N
AH 74	rustic maple	classic touch	basic			
AHB 99	natural maple	classic touch	basic			
BU 88	flowery beech	classic touch	basic			
CB 225	coco bolo white	soft touch	trend			
Ei 424	platinum oak	pure touch	trend			
Ei 727	amber oak	pure touch	trend			
EiB 310	pale oak	classic touch	basic			
EiC 424	platinum oak cross	pure touch	trend			
EiC 727	amber oak cross	pure touch	trend			
EiP 356	oak italia	classic touch	basic			
ES 242	ash tree white pore	classic touch	basic			
NU 736	walnut noce	classic touch	basic			
Pi 11	pine light	pure touch	trend			
Pi 230	pine white	pure touch	trend			
PiC 11	pine light cross	pure touch	trend			
PiC 230	pine white cross	pure touch	trend			
PiC 44	pine grey cross	pure touch	trend			
WE 716	wenge	classic touch	trend			
DekoRit DOORS WITH DECOR FOIL SURFACES						
DE 223	classic white		basic	RAL 9010		
DE 24	plain white		basic	RAL 9010		S 0502-G
DE 30	pale oak		basic			
DE 736	walnut noce		basic			
DE 74	rustic maple		basic			
DE 88	flowery beech		basic			
DEC 11	pine light cross		basic			
DEC 44	pine grey cross		basic			
DES 25	ash tree white pore		basic			
Priming film, brush-on						
WestaLack DOORS WITH WHITE LACQUER AND COLOURED LACQUER						
	arctic white	semi-matt	basic	RAL 9016		S 0502-G
	classic white	semi-matt	basic	RAL 9010	100 90 05	S 0500-N
	agate	semi-matt	trend	RAL 7015	260 40 05	S 6502-B
	ferrum	semi-matt	trend	RAL 7047	000 80 00	S 2000-N
	cement	semi-matt	trend	RAL 7004	000 65 00	S 4500-N
	macchiato	semi-matt	trend	RAL 7048	060 60 05	

¹⁾ The terms used for surface structures differ between GetaLit® and PortaLit®.

The PortaLit® 'classic touch' designation covers GetaLit® parchment, pore EB and pore F finishes.

PortaLit® 'soft touch' is equivalent to GetaLit® pearl matt, and PortaLit® 'pure touch' is GetaLit® Innato und Legnato.

WHICH VERSION WOULD YOU LIKE?

Rebate options

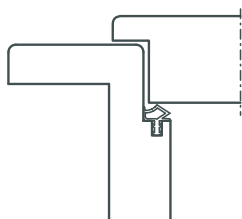

REBATED

Rebated doors have been a classic for decades. They cover the gap between the door frame and the door leaf and hardly let any light through when the door is closed.

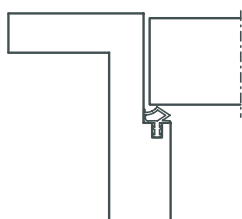

FLUSH CLOSING

For lovers of design: the square version of the flush-closing door. The flush surface of the door and the frame creates a pared down, elegant effect. It looks even more puristic with concealed hinges (see page 58).

Door edge options

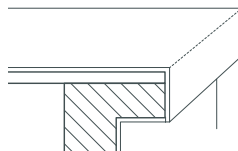

SQUARE EDGE

The simplest kind of edge, the square edge has a pared-down, timeless look.

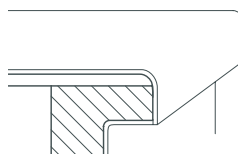

ROUND EDGE

Round edges allow for soft transitions and make the door edges more resistant to knocks and dirt.

Rebate options		rebated	flush closing
STANDARD INTERIOR DOORS	Page		
PortaLit® surface	46–47	■	■
DekoRit® finish	48	■	■
WestaLack® finish	49	■	■
DOOR SERIES	Page		
Doors with glass openings	10 – 11	■	■
Doors with muntins	12 – 13	■	■
View	16 – 17	■	■
Provence	20 – 25	■	■
Westaline	28 – 31	■	■
Smartline	32 – 33	■	■
Lineo	34 – 35	■	■
Sliding doors running in front of the wall	36 – 37		■
Sliding doors running inside the wall	38 – 39		■

Door edge options		square edge	round edge ¹⁾
STANDARD INTERIOR DOORS	Page		
PortaLit® finish	46–47	■	■
DekoRit® finish	48	■	■ ²⁾
WestaLack® finish	49	■	■
DOOR SERIES	Page		
Doors with glass openings	10 – 11	■	■
Doors with muntins	12 – 13	■	■
View	16 – 17	■	■
Provence	20 – 25	■	■
Westaline	28 – 31	■	■
Smartline	32 – 33	■	
Lineo	34 – 35	■	■
Sliding doors running in front of the wall	36 – 37	■	
Sliding doors running inside the wall	38 – 39	■	

¹⁾ only in the rebated version

²⁾ decors DEC 11 and DEC 44 not available in the rounded-edge version

PRODUCT OVERVIEW: REBATE, EDGES AND CORES

Door leaf cores

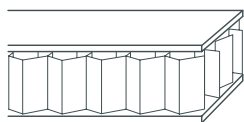

SPECIAL HONEYCOMB CORE

The affordable core for interior doors with low requirements. The fact that it weighs very little is a plus.



Our recommendation

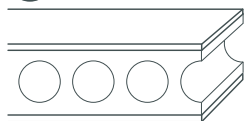

HOLLOW CHIPBOARD CORE

If you want a solid door that will last a long time, choose the hollow chipboard core – it offers a high level of stability and surface smoothness.



SOLID CHIPBOARD CORE

The core for interior doors with high requirements. Ideal for apartment entrance doors with high soundproofing requirements, particularly in combination with a floor seal. Offers a high degree of mechanical strength and very good thermal insulation.

Cores		Special honeycomb core	Hollow chipboard core	Solid chipboard core
STANDARD INTERIOR DOORS	Page			
PortaLit® finish	46–47	■	■	■
DekoRit® finish	48	■	■	■
WestaLack® finish	49	■	■	■
DOOR SERIES	Page			
Doors with glass openings	10 – 11	■	■	■
Doors with muntins	12 – 13		■	■
View	16 – 17			■
Provence	20 – 25	■ ¹⁾		■
Westaline	28 – 31		■	■
Smartline	32 – 33	■	■	■
Lineo	34 – 35		■	■
Sliding doors running in front of the wall	36 – 37		■	
Sliding doors running inside the wall	38 – 39		■	

¹⁾ only available with Provence Types 4002 and 4002-B

DOOR FRAMES

Wooden lining frames

Just like a precious painting, your interior door needs the right frame if you want to get the best effect. We provide a wide range of high-quality wooden lining frames. They are available for all normal wall thicknesses, with architrave widths of up to 100 mm and in various versions – from classic to modern. The flush-closing types allow for a seamless transition from the door leaf to the frame, creating an elegant overall impression.

Rebated

Flush closing

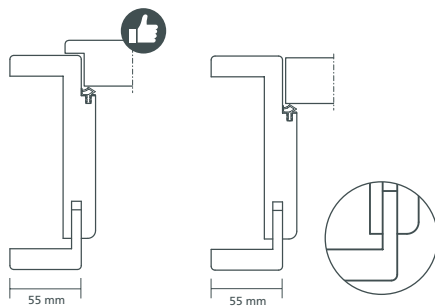

STANDARD WOODEN FRAME WITH ROUNDED EDGE (TYPE SL)

A well-rounded result – no matter what surface you choose. Suitable for all doors with square or round edges. Also available with architrave widths of 65, 75, 80 and 100 mm.

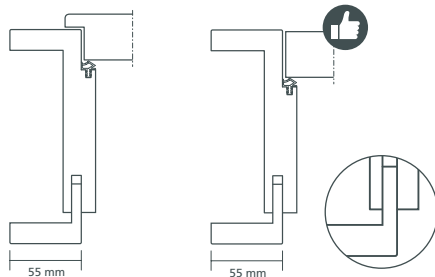

WOODEN FRAME WITH NARROW ROUNDED EDGE (TYPE SE)

With a narrow radius – for square and round door edges. Also available with architrave widths of 65, 75, 80 and 100 mm.

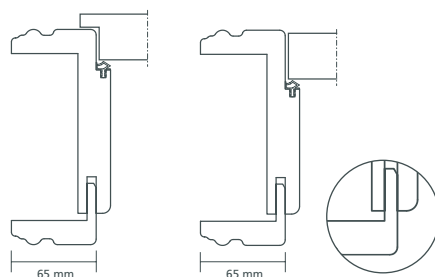

PROFILED WOODEN FRAME P1

For doors with a great profile! Our profiled frames are the favourites for our Provence country house doors. Available in the Westalack® classic white (RAL 9010) surface finish.

Determining the correct door-frame dimensions

What size should your door frame be? It must always fit exactly. The table below will help you to correctly calculate the frame size you need to order.

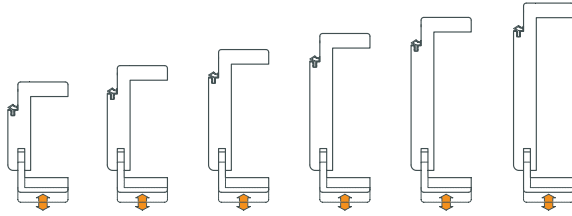

Rebated								
Size to be ordered (mm)	65	70	80	100	125	145	165	185
Adjustment range: from	65	70	80	100	121	141	161	181
to	75	80	96	116	141	161	181	201
Size to be ordered (mm)	205	225	240	270	290	310	330 ¹⁾	
Adjustment range: from		201	221	236	266	286	306	326
to		221	241	256	286	306	326	346

Flush closing								
Size to be ordered (mm)		80	100	125	145	165	185	
Adjustment range: from			80	100	121	141	161	181
to			90	116	141	161	181	201
Size to be ordered (mm)		205	225	240	270	290	310	330 ¹⁾
Adjustment range: from		201	221	236	266	286	306	326
to		221	241	256	286	306	326	346

¹⁾ Available for a wall thickness up to 620 mm

Special frames

Block frames are extremely popular with architects and interior designers and turn every door into a design feature. Depending on the structure and installation, a distinction is made between edge frames and butt frames:

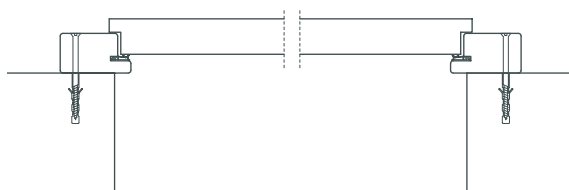

EDGE FRAMES

Are simply mounted upon the wall. They allow for door openings with a large clear passage width. They are particularly suitable for low wall thicknesses.

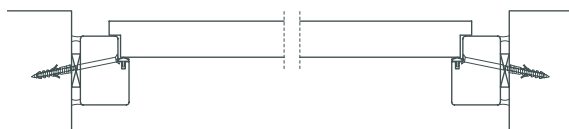

BUTT FRAMES

Don't require brickwork abutment at all. They create a door system that is completely flush with the wall in the flush-closing version. Also available in conjunction with a draught excluder.

Limited choice of decor on request.

WHAT DOES IT MEAN?

An overview of important technical terms

Have you always wondered how a Westag & Getalit door is properly installed? One thing is certain: there are a lot of things to take into account. For example, the DIN direction of the door is very important. It determines whether the door opens to the right or to the left into the room and what side the handle is on. We have put together a few important technical terms for you below. Prefer to spend your time thinking of other things? Then skip this page and contact your nearest Westag & Getalit trade partner. They will be happy to provide reliable, expert advice.

Technical terms for door dimensions

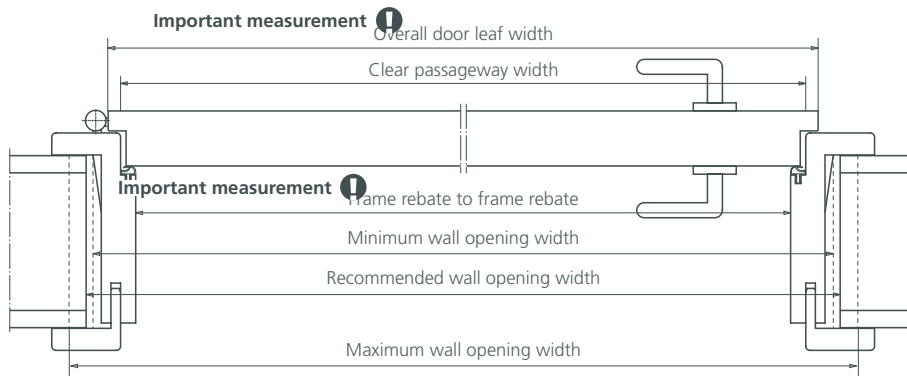

Directions for doors according to DIN

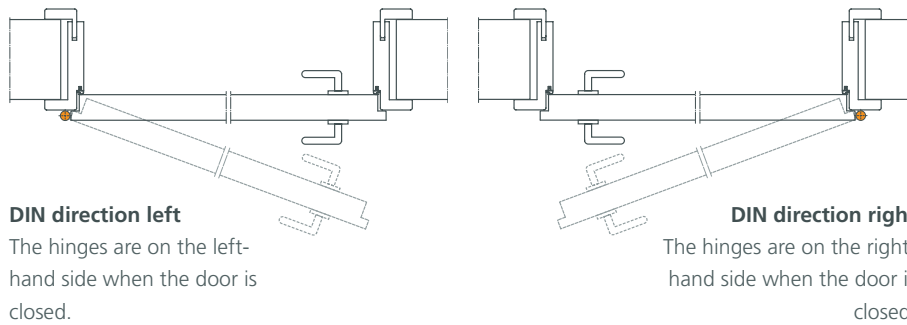

DIN directions for sliding doors

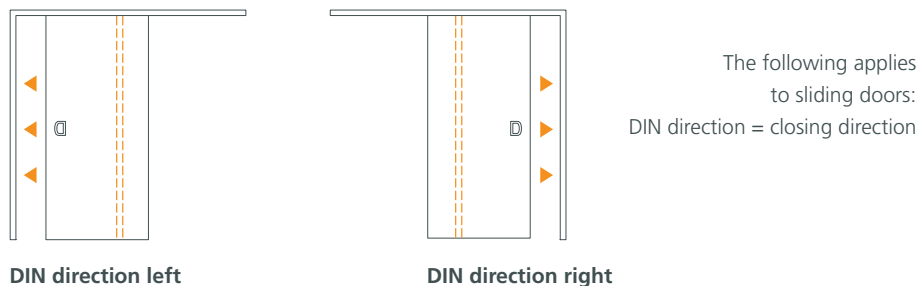



DIN dimensions for doors and frames

Door leaf size (rebated)	Door leaf size (flush closing)	Minimum wall opening	Recommended wall opening	Maximum wall opening
Width in mm (for wooden frames)				
610	584	635	650	680
735	709	760	775	805
860	834	885	900	930
985	959	1010	1025	1055
1110	1084	1135	1150	1180
1235	1209	1260	1275	1305
Height in mm (for wooden frames)				
1985	1972	2005	2010	2025
2110	2097	2130	2135	2150
2235	2222	2255	2260	2275
2360	2347	2380	2385	2400
2485	2472	2505	2510	2525



Independent of the DIN dimensions specified in the table on the left, we can manufacture doors in almost every size up to 2485 x 1290 mm.

For most Design and country house doors, sizes up to 2110 x 985 mm are available. For doors with non-standard sizes, the profiles are kept constant and the lateral surfaces are matched to the required size.



Dimensions for doors and frames

Door leaf size (rebated)	Door leaf size (flush closing)	Minimum wall opening	Recommended wall opening	Maximum wall opening
Width in mm (for wooden frames)				
650	624	675	690	720
700	674	725	740	770
750	724	775	790	820
800	774	825	840	870
850	824	875	890	920
900	874	925	940	970
950	924	975	990	1020
Height in mm (for wooden frames)				
2015	2002	2035	2040	2055
2030	2017	2050	2055	2070
2115	2097	2130	2135	2150

HINGES AND LOCKS

A brief introduction to fittings

What level of security do you require? The kind of locks you choose will have a significant impact on how happy you'll feel with your new doors. Do you have doors such as apartment entrance doors or a door to the boiler room where it would make sense to use a security lock – or where it's even mandatory? Do you want a special bathroom lock for the bathroom door?

It's also worth looking at hinges. Depending on the door frame type and the amount of strain the door will be under, you can choose from a range of different models. The Tectus TE 340 is great for those who love good engineering and design. The hinges are not visible when the door is closed, and the flush-closing door fits directly into the frame. It's a great example of pared-down design with maximum impact.

Locks

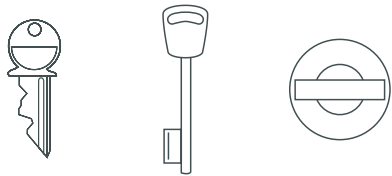

Profile cylinder locks (PZ) Single tumbler locks (BB) Standard bathroom locks (BAD)

Hinges for wooden frames rebated

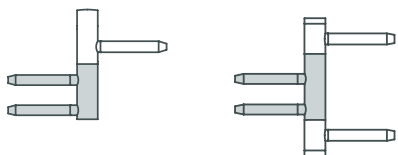

Hinge V 0020 Frame section V 3400 WF Hinge V 0026 WF Frame section V 4400 WF

flush closing

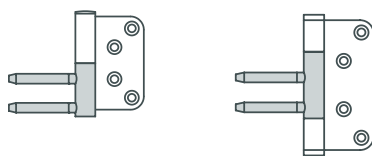

Hinge V 0080 Frame section V 3400 WF Hinge V 0087 WF Frame section V 4400 WF

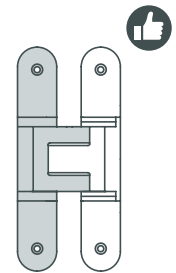

Hinge Tectus TE 340 3D (concealed)

Hinges for steel frames rebated

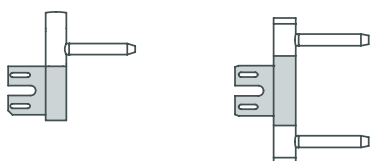

Hinge V 0020 Frame section V 8100 Hinge V 0026 WF Frame section V 8000

flush closing



Hinge V 0080 WF Frame section V 8100 WF Hinge V 0087 WF Frame section V 8000

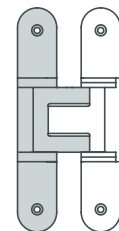

Hinge Tectus TE 340 3D (concealed)

Our recommendation

Hinge (door) Frame section (frame)



WAT [®] standard		+ Fire protection	
		+ Protection against intrusion and burglary	
	+ Soundproofing	■	■
	Climate class III	■	■
	Duty group S	■	■
	3-part hinges	■	■
	Profile cylinder lock (PZ)	■	■

Components of apartment entrance door sets ('WAT')

SAFE AND SOUND – DAY AND NIGHT

Everyone wants to feel comfortable at home. This is where doors come in: they play an important role in our lives, giving us that all-important sense of safety and security, protecting us and keeping out noise and unwelcome guests. At Westag & Getalit you can put together your own individual doors with the exact technical features you need. The result: interior doors and apartment entrance doors that are tailored to your requirements and have the functions and the technology that suit you and your lifestyle.



BASIC PROTECTION FOR PEACE OF MIND

A simple feeling of security – the basic model for those with high standards



Even our standard version has plenty of features. At Westag & Getalit, that's a matter of course, because we believe that secure doors don't have to come at a high price. Our apartment entrance doors meet strict environmental requirements and withstand tough conditions as standard.

An important detail: all doors from Westag & Getalit bear the RAL quality mark, which certifies that a product has been manufactured in compliance with strict, standardised quality criteria. The recommendations for use in accordance with RAL GZ 426 ensure that you're always on the safe side when realising your construction project.



The use of the appropriate climate class prevents warping if the temperatures vary considerably on either side of the door.



	I Low	II Medium	III High	N Normal	M Medium	S High	E Extreme
	Honey-comb Hollow chipboard	Solid chipboard	Solid chipboard	Honey-comb Hollow chipboard	Hollow chipboard Solid chipboard	Solid chipboard	Solid chipboard ¹⁾
Place of use	Door leaf climate class			Door leaf duty group			
Interior doors leading to the living room, study, bedroom	■			■			
Children's room, kitchen, storeroom	■			■			
Bathroom, WC	■	■		■			
 Apartment entrance door			■			■	
Doors to attic			■		■		
Basement doors		■			■		
Teaching rooms, barracks, large kitchens, laboratories		■	■				■

¹⁾ only with appropriate frame structure and fittings



Our recommendation



IT'S BETTER TO BE SAFE THAN SORRY

Apartment entrance doors with soundproofing and/or fire protection (optional)

Welcome to the quiet zone. Doors with soundproofing ensure that noise stays where it belongs – outside. Even our standard apartment entrance doors meet all soundproofing and safety requirements in accordance with DIN 4109. This means you get three features in one: soundproofing, security and load-bearing capacity.

Westag & Getalit's fire-rated doors provide a high level of protection against fire. Like all the interior and apartment entrance doors in our range, they look good and have great technical features. In addition to fire-rated doors, we also offer combined versions for additional smoke protection requirements and pure smoke protection doors.

Soundproofed door sets: function

Soundproofing class	Laboratory test result	Recommendation for use
SK27	32 dB	Standard apartment entrance door (minimum requirement acc. to DIN 4109)
SK32	37 dB	Apartment entrance door with extra convenience
SK37	42 dB	Apartment entrance door leading directly into the living area, without vestibule (recommended for increased soundproofing as per DIN 4109, Supplement 2)

Fire-rated door sets: function

Door structures	Function
Fire-rated doors (in acc. with DIN 4102 and DIN EN 1634)	Protection against fire for 30, 60 or 90 minutes
Smoke protection doors (in acc. with DIN 18095 and DIN EN 1634)	Prevention of penetration by smoke, which contains poisonous gases and impairs visibility



Our tip: the installation of soundproofing doors isn't just a good idea in commercial and industrial buildings. Installing a soundproof door for the children's room can also be a good idea.



Fire/smoke protection doors are suitable for establishing harmonious shifts between the living space and the garage or boiler room.



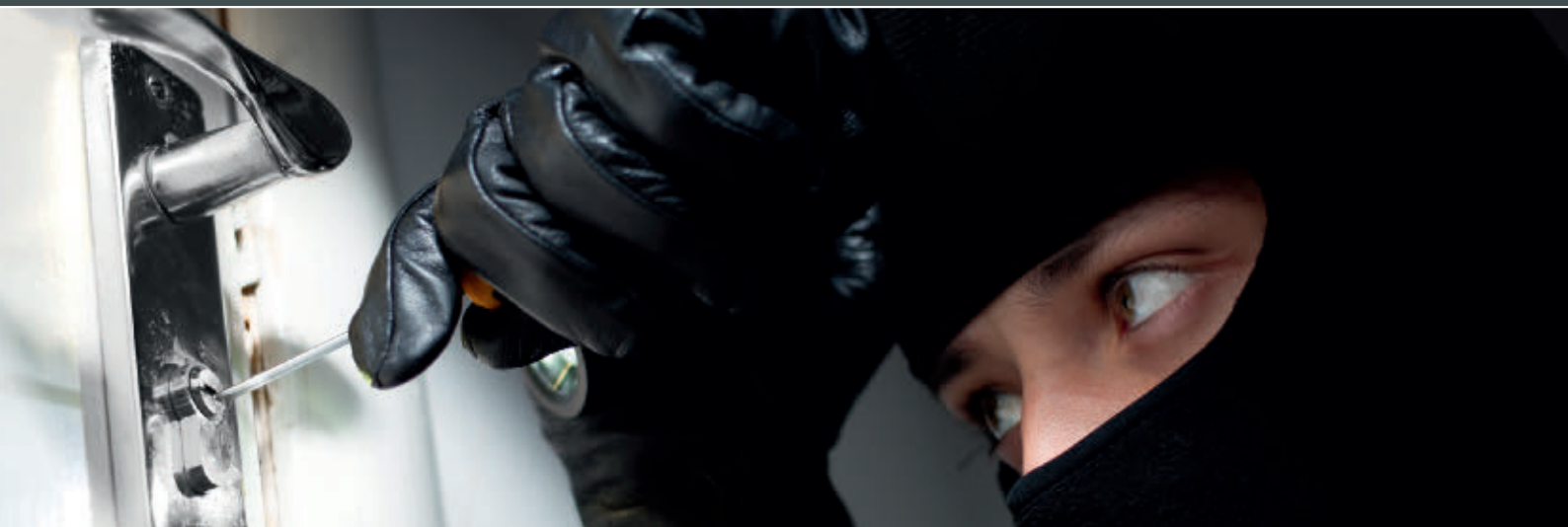

MAKING LIFE DIFFICULT FOR BURGLARS

Apartment entrance doors with protection against intrusion and burglary (optional)

A burglary is committed somewhere in Germany every two minutes. Many burglars break in during the day, often via the entrance door. With the right security equipment, 40 per cent of break-ins can be prevented. Westag & Getalit doors protect you from uninvited guests and make your home a safe haven.

Our door sets are tested according to DIN and EU standards and have test certificates and the corresponding markings. Depending on your security needs, you can select additional equipment options, such as a three-point locking system or hinge side protection to prevent the door from being levered open. And a spyhole allows you to take a look at every caller before opening the door.



Recommendations for use acc. to resistance class as per DIN EN V 1627-30 and EN 1627-30

Burglar/intruder profile	Security requirements	WK ¹⁾	RC ²⁾
Casual burglar using simple tools	Standard security level for apartment entrance exposed to an average risk	2	2
Casual burglar using heavy lever tools	Increased security level for apartment entrance exposed to a high risk	3	3

¹⁾Widerstandsklasse ²⁾Resistance Class

Parts of a burglar-resistant apartment entrance door set

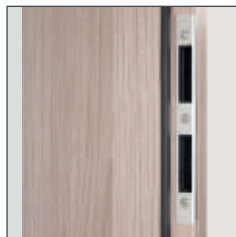

Reinforced locking plate
prevents simple levering out



Special handle
for additional security

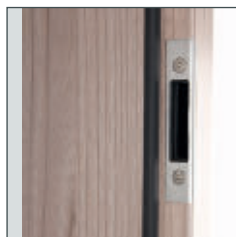

Casing for 3-point-locking system (optional)



Three-point locking system, 3 locking points (optional)
for maximum security

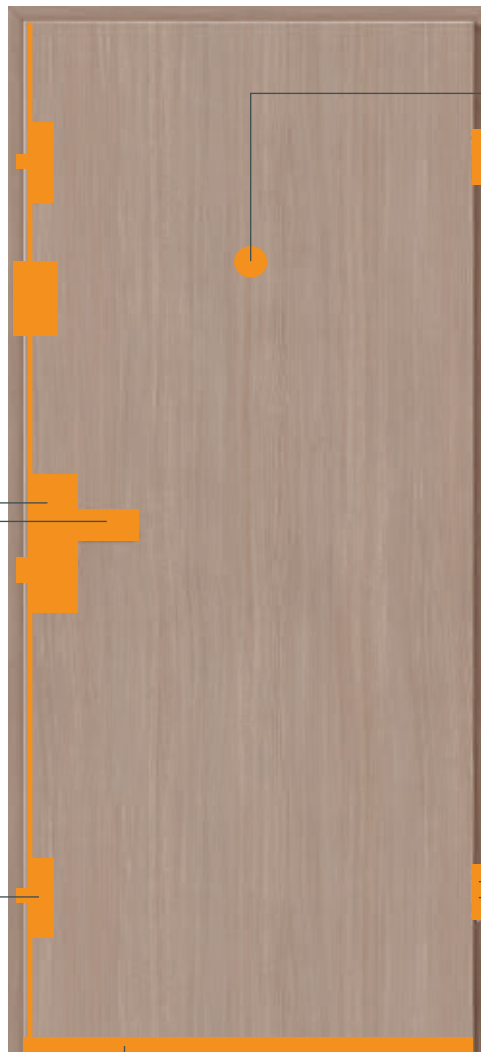

Spyhole (optional)
increases the resident's own protection



Hinge side protection
minimises weak points in the hinge area



Security hinges
for higher tear-out resistance



Lowerable floor seal
reduces draughts and keeps external noise out reliably

